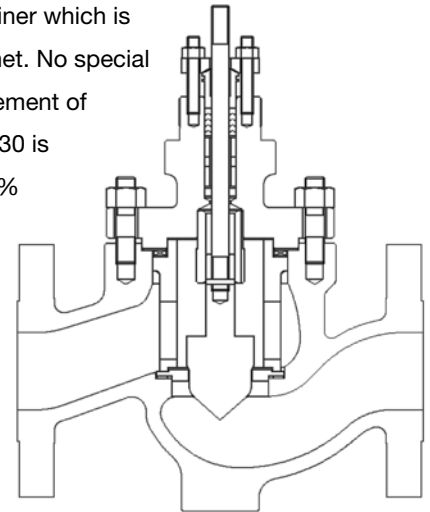


## FEATURES

- Cage-retained "quick change" seat ring simplifies maintenance.
- Metal seats for a variety of services and ANSI Class IV and V shutoff.
- Soft seat inserts provide ANSI Class VI shutoff.
- Choice of 17-4PH or 316 stainless steel trim is standard.
- A wide range of trim sets is available; up to 7 reductions on some sizes.
- Bellows seal bonnet is available for difficult or hazardous chemical applications.
- Optional live-loaded PTFE and graphite packing.

## Series G130 Globe And Angle Valves 1/2"-6" (DN15 - 150) ANSI Class 150-600

The G130 Series is a single-seated, top-guided control valve with "quick change" trim. The seat ring is held in place by a retainer which is captured between the valve body and bonnet. No special tools are required for the removal or replacement of the seat ring. The contoured plug of the G130 is available with 3 standard trim sizes (full, 60% and 40%) and up to 7 reductions in some sizes. The complete offering of body, bonnet and trim options make the G130 the first choice for the widest range of medias, temperatures and pressures.



## Specifications

**Body Style:** Globe or angle.

**Body Size:** Globe - 1/2" through 6" (15-150 mm).

Angle - 1/2" through 2" (15-50 mm).

**Body Rating:** ANSI Class 150, 300, 600.

**Body Materials:** Carbon steel, chrome-moly steel, stainless steel, other castable alloys including Monei®, Hastelloy®C, and Alloy 20 available on application.

**End Connections:** NPT threaded or socket weld (1/2" through 2"); ANSI flanged (1/2" through 6"); ANSI butt weld (1" through 6"); others available on request.

**Bonnets:** Plain, extension, bellows seal, ultra-low temperature extension.

**Trim Style:** Unbalanced contoured plug, cage retained seat ring (refer to page 3).

**Trim Characteristic:** Linear and equal percentage.

**Flow Coefficient:**  $C_v$  from 0.48 through 390 (refer to Tables on page 3).

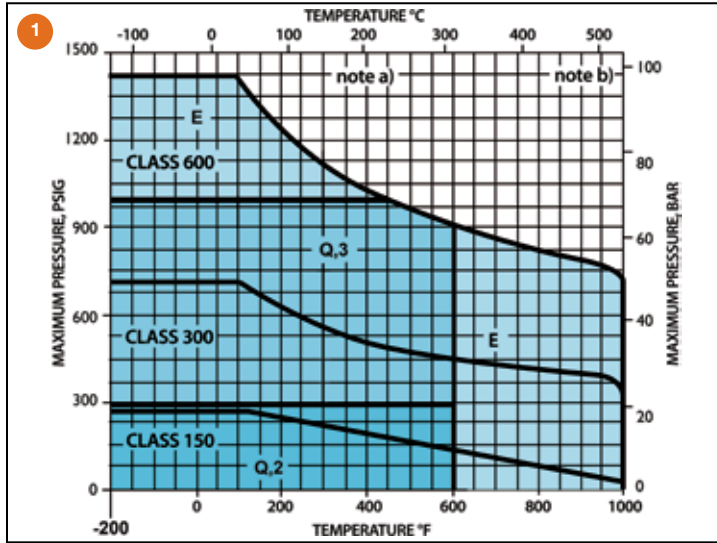
**Leakage Class:** IV, V, VI.

**Actuators:** Standard bonnet mount will accept spring-diaphragm, piston and other actuators. For actuator selection, refer to KOSO Hammel Dahl actuator selection guide.

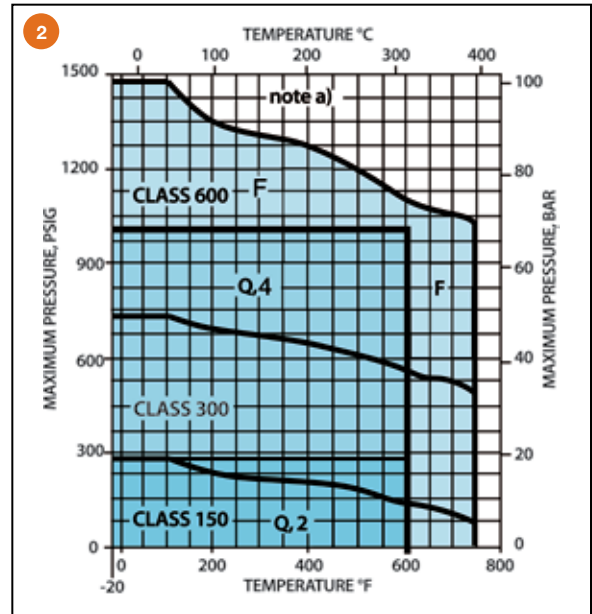
# Material Selection

These charts should be used to select the pressure class and trim material combination. The set of curves sloping downward to the right are the pressure rating curves for each ANSI pressure class listed in ANSI B16.34. In each case the curve designates the maximum pressure and temperature for the class listed directly below the curve. The bold boundaries mark the recommended pressure and temperature limits for trim material combinations listed in the tables below. All recommendations are generalized and may be subject to adjustment based upon hydraulic considerations determined during the valve sizing process.

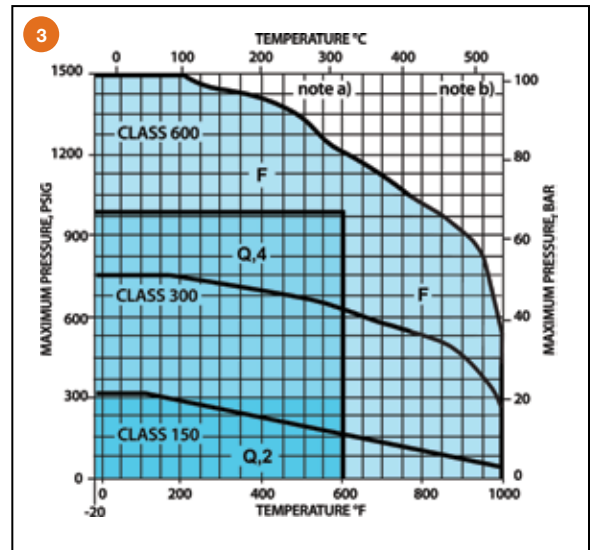
**Figure 1. Trim Chart for Stainless Steel Body (ASTM A351, CF8M)**



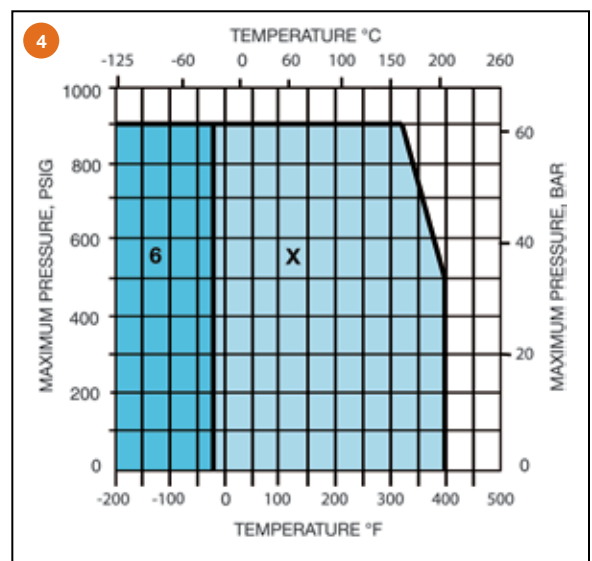
**Figure 2. Trim Chart for Carbon Steel Body (ASTM A216, WCB)**



**Figure 3. Trim Chart for Chrome-Moly Body (ASTM A217, WC9)**



**Figure 4. PTFE Soft Seat Rating Chart**



**Table 1. G130 Standard Trim Materials**

Trim Code	Plug	Seat Ring	Seat Retainer	Guide Bushing	Stem
2	316 SS	316 SS	316 SS	17-4 PH/AG	316 SS
Q	17-4 PH	17-4 PH	17-4 PH	17-4 PH/AG	17-4 PH
3	316 SS/HFS	316 SS/HFS	316 SS	17-4 PH/AG	316 SS
4	316 SS/HFS	316 SS/HFS	17-4 PH	17-4 PH/AG	316 SS
E	316 SS/HFS+P	316 SS/HFS	316 SS	Alloy 12	316 SS
F	316 SS/HFS+P	316 SS/HFS	17-4 PH	Alloy 12	316 SS
X	316 SS/PTFE	316 SS	316 SS	316 SS/AG	316 SS
6	316 SS/KEL-F	316 SS	316 SS	17-4 PH/AG	17-4 PH

**NOTES TO TABLE AND TRIM CHARTS**

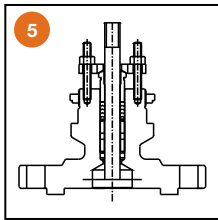
- a) Above +600 °F (+316 °C) extension bonnet is required.
- b) For service temperature above +1000 °F (+538 °C) contact your local representative.
- c) Unless otherwise specified, the hard-facing is Alloy 6.
- d) CP = Chrome plated.
- e) For soft-seat trim selections see Figure 4.
- f) KOSO HAMMEL DAHL reserves the right to substitute materials when appropriate based upon service or availability.
- g) Guiding surfaces are treated to prevent galling.

**Table 2. Valve Leakage Classes**

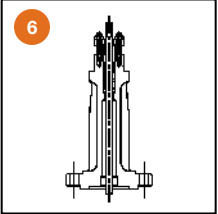
Seat Material	ANSI Class
Metal	IV, V
PTFE Insert	VI

Above leakage classes as defined in ANSI B16.104.

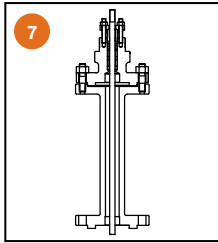
### Bonnet Types



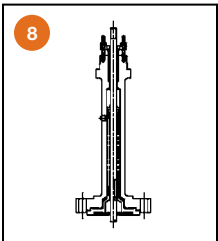
**Figure 5. Plain Bonnet**  
A plain bonnet is used when the flow media remains between -50°F to 600°F (-46°C to +316°C); available with standard or live-loaded packing configurations.



**Figure 6. Extension Bonnets**  
An extension bonnet is required for high temperature applications from +600°F to +1000°F (+316°C to +538°C).

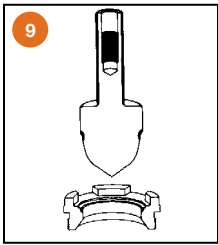


**Figure 7. Ultra-low Temperature Extension Bonnets**  
Ultra-low temperature extension bonnet is available for use down to -320°F (-195°C).

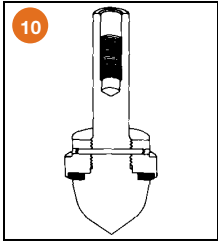


**Figure 8. Bellows Seal Bonnets**  
A bellows seal bonnet is used when stem leakage cannot be tolerated because media is toxic, flammable, explosive or precious. Refer to the Bellows Seal Rating Chart for bellows temperature and pressure limits. For all sizes, the bellows seals are externally pressurized.

### Plug and Seat Designs

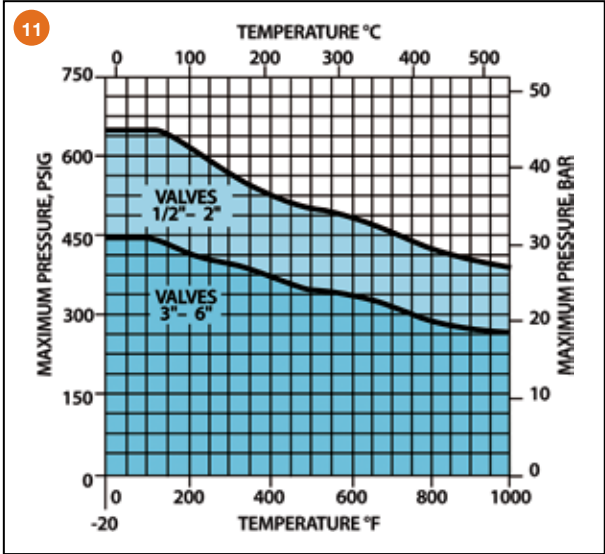


**Figure 10. Standard Plug**  
The standard metal seated plug provides ANSI Class IV shutoff. ANSI Class V is available with lapping and proper actuator selection. Standard flow direction is from under the plug.



**Figure 11. Soft Seat Design**  
The optional PTFE soft-seat insert is captured in the plug head and provides ANSI Class VI shutoff. For valves with Cv of 5.4 or smaller, the soft-seat insert is captured in the seat ring.

**Figure 9. Bellows Seal Rating Chart**



**Table 3. Flow Coefficient (Cv) at Maximum Travel**

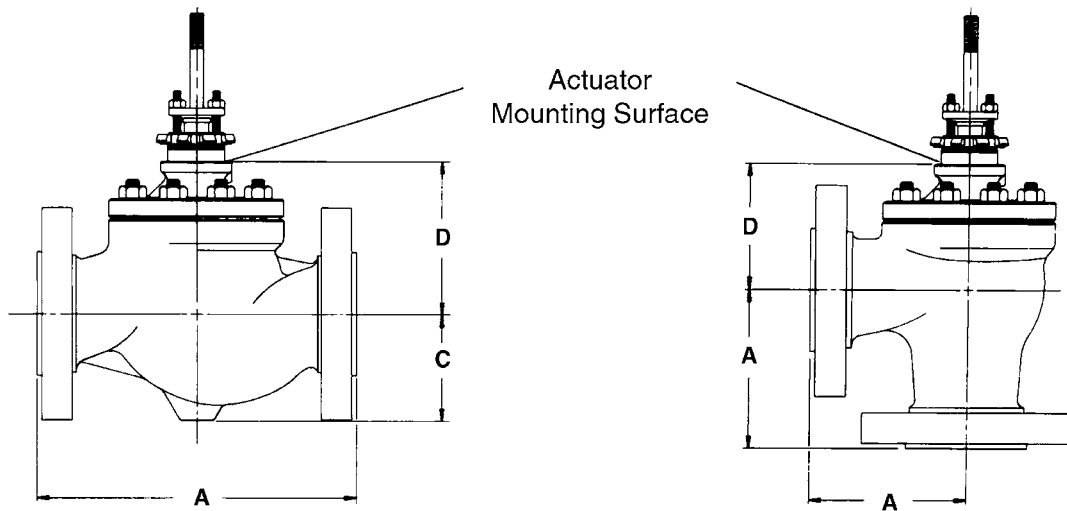
Characteristic	Trim Size & Code	1/2	3/4	1	1-1/2	2	3	4	6	
Equal Percentage	Full Size A	5.4	9.0	13.4	31	50	105	190	390	
	1 Reduction B	3.6	5.4	9.0	13.9	32	49	105	192	
	2 Reduction C	1.8	3.6	5.4	7.0	13.2	35	55	120	
	3 Reduction D	1.4	1.8	3.6	Not Available					
	4 Reduction E	1.0	1.4	1.8						
	5 Reduction F	0.67	1.0	1.4						
	6 Reduction G	—	0.67	1.0						
7 Reduction H	—	—	0.67							
Linear	Full Size A	4.5	6.9	13.0	32	51	106	217	390	
	1 Reduction B	2.5	4.5	6.9	13.9	32	48	115	198	
	2 Reduction C	1.7	2.5	4.5	5.8	13.5	35	53	120	
	3 Reduction D	1.1	1.7	2.5	Not Available					
	4 Reduction E	0.63	1.1	1.7						
	5 Reduction F	0.48	0.63	1.1						
	6 Reduction G	—	0.48	0.63						
7 Reduction H	—	—	0.48							

# Weights and Dimensions

**Table 4. G130 Globe Body Dimensional Data — inches (mm) ANSI Classes 150-600**

Body Size DN/in.	Travel	A						C	D				Approx. Weight lb (kg)
		Screwed or Socket Weld	Flanged			Butt Weld			Plain Bonnet	Extn. Bonnet	ULT Extn. Bonnet	Bellows Bonnet	
			Class 150-600	Class 150	Class 300	Class 600	Class 150-300						
1/2 (15)	1.00 (25)	8.12 (206)	7.25 (184)	7.50 (191)	8.00 (203)	—	—	2.38 (60)	5.38 (137)	9.59 (244)	13.50 (343)	14.10 (358)	25 (11)
3/4 (20)	1.00 (25)	8.25 (210)	7.25 (184)	7.62 (194)	8.12 (206)	—	—	2.38 (60)	5.38 (137)	9.59 (244)	13.50 (343)	14.10 (358)	25 (11)
1 (25)	1.00 (25)	8.25 (210)	7.25 (184)	7.75 (197)	8.25 (210)	8.25 (210)	8.25 (210)	2.38 (60)	5.38 (137)	9.59 (244)	13.50 (343)	14.10 (358)	25 (11)
1-1/2 (40)	1.12 (28)	9.88 (251)	8.75 (222)	9.25 (235)	9.88 (251)	9.88 (251)	9.88 (251)	3.19 (81)	5.88 (149)	11.10 (282)	15.50 (394)	16.10 (409)	65 (29)
2 (50)	1.12 (28)	11.25 (286)	10.00 (254)	10.50 (267)	11.25 (286)	11.25 (286)	11.25 (286)	3.62 (92)	5.92 (150)	11.45 (291)	17.52 (445)	18.12 (460)	70 (32)
3 (80)	1.50 (38)	—	11.75 (298)	12.50 (318)	13.25 (337)	13.25 (337)	13.25 (337)	4.38 (111)	7.27 (185)	11.81 (300)	19.27 (489)	19.27 (489)	145 (66)
4 (100)	1.50 (38)	—	13.88 (353)	14.50 (368)	15.50 (394)	15.50 (394)	15.50 (394)	5.31 (135)	8.08 (205)	11.96 (304)	23.89 (607)	23.89 (607)	230 (104)
6 (150)	2.25 (57)	—	17.75 (451)	18.62 (473)	20.00 (508)	20.00 (508)	20.00 (508)	6.62 (168)	9.87 (251)	14.68 (373)	26.06 (662)	26.06 (662)	470 (213)

\* Weights are for ANSI Class 600 flanged valves with plain bonnet.



**Table 5. G131 A ngle Body Dimensional Data — inches (mm) ANSI Classes 150-600**

Body Size DN/in.	Travel	A						D				Approx. Weight lb (kg)
		Screwed or Socket Weld	Flanged			Butt Weld		Plain Bonnet	Extn. Bonnet	ULT Extn. Bonnet	Bellows Bonnet	
			Class 150-600	Class 150	Class 300	Class 600	Class 150-300					
1/2 (15)	1.00 (25)	4.06 (103)	—	—	—	—	—	4.56 (116)	8.78 (223)	12.69 (322)	13.29 (338)	25 (11)
3/4 (20)	1.00 (25)	4.12 (105)	3.62 (92)	3.81 (97)	4.06 (103)	—	—	4.56 (116)	8.78 (223)	12.69 (322)	13.29 (338)	25 (11)
1 (25)	1.00 (25)	4.12 (105)	3.62 (92)	3.88 (99)	4.12 (105)	3.62 (92)	3.62 (92)	4.56 (116)	8.78 (223)	12.69 (322)	13.29 (338)	25 (11)
1-1/2 (40)	1.12 (28)	4.94 (125)	4.38 (111)	4.62 (117)	4.94 (125)	4.94 (125)	4.94 (125)	5.19 (132)	10.41 (264)	14.81 (376)	15.41 (391)	65 (29)
2 (50)	1.12 (28)	5.62 (143)	5.00 (127)	5.25 (133)	5.62 (143)	5.62 (143)	5.62 (143)	5.00 (127)	10.52 (267)	16.59 (421)	17.19 (437)	70 (32)

# How To Order

To completely specify a control valve, make a selection from each category in the Valve Model Coding System below. The assembled codes create a complete valve model number. The Valve Model Coding System displays the standard product offering for this product line. An extensive number of options and variations exist, which are not listed. For options not shown or to enter an order, contact your local sales representative.

1	Series Models
G130	Globe Style Body
G131	Angle Style Body

8	Trim Size
A	Full Size
B	1 Reduction
C	2 Reduction

Refer to page 3 for additional trim reduction options.

2	Body Size
D	1/2" (15 mm)
E	3/4" (20 mm)
F	1" (25 mm)
H	1-1/2" (40 mm)
J	2" (50 mm)
L	3" (80 mm)
N	4" (100 mm)
Q	6" (150 mm)

9	Trim Materials					
	Trim Code	Plug	Seat Ring	Seat Retainer	Guide Bushing	Stem
2	316SS	316 SS	316 SS	316 SS	17-4 PH/AG	316 SS
Q	17-4 PH	17-4 PH	17-4 PH	17-4 PH	17-4 PH/AG	17-4 PH
3	316 SS/HFS	316 SS/HFS	316 SS	316 SS	17-4 PH/AG	316 SS
4	316 SS/HFS	316 SS/HFS	17-4 PH	17-4 PH	17-4 PH/AG	316 SS
E	316 SS/HFS+P	316 SS/HFS	316 SS	316 SS	Alloy 12	316 SS
F	316 SS/HFS+P	316 SS/HFS	17-4 PH	17-4 PH	Alloy 12	316 SS
X	316 SS/PTFE	316 SS	316 SS	316 SS	316 SS	316 SS
6	316 SS/KEL-F	316 SS	316 SS	316 SS	17-4 PH/AG	17-4 PH
5	Monel	Monel	Monel	Monel	K-Monel/AG	K-Monel
G	Hastelloy B	Hastelloy B	Hastelloy B	Hastelloy B	Hastelloy B/AG	Hastelloy B
H	Hastelloy C	Hastelloy C	Hastelloy C	Hastelloy C	Hastelloy C/AG	Hastelloy C
J	Alloy 20	Alloy 20	Alloy 20	Alloy 20	Alloy 20/AG	Alloy 20

3	Body Rating
G	ANSI Class 150
H	ANSI Class 300
F	ANSI Class 600

4	Body Material
C	Carbon Steel (ASTM A216, WCB)
E	Stainless Steel (ASTM A351, CF8M)
2	Chrome-Moly Steel (ASTM A217, WC9)
M	Hastelloy B (ASTM, A494, N-12 MW)
N	Hastelloy C (ASTM, A494, CW-12 MW)
P	Monel (ASTM, A494, M-35-1)
Q	Alloy 20 (ASTM, A351, CN7M)

10	Packing Materials
	<b>-200 °F to +450 °F (-129 °C to +232 °C)</b>
G	TFE V-Ring/Spacer
U	TFE Impregnated PTFE Braid
Y	Double TFE V-Ring/Spacer
W	Lubricated Aramid Braid
B	Live-loaded TFE V-Ring
	<b>+450 °F to +900 °F (+232 °C to +482 °C)</b>
9	Laminated Graphite

5	End Connections
3	Raised Face Flange
4	NPT Threaded
6	Socket Weld
8	Butt Weld Sch. 40
9	Butt Weld Sch. 80

11	Variations
—	None
A	Body Drain
B	Bonnet Lube Connection Only
D	Bonnet Lube Connection w/ISO Valve
G	Chlorine Clean
S	Oxygen Clean
J	125 RMS Flange Face Finish
K	17-4 PH Stem
L	Tack Weld Guide Bushing Only
N	NACE MR 0175/ISO 15156 Compliance
R	Inert Gas/Liquid Cleaning
T	28/30 Degree Seat Angle

6	Bonnet Type
2	Plain
3	Ultra-low Temperature Extension
4	Extension
5	Bellows

7	Trim Characteristics
C	Linear
E	Equal Percent

## D/R Series Linear Spring Diaphragm Pneumatic Actuators

KOSO Hammel Dahl linear spring diaphragm pneumatic actuators are rugged units designed for reliable operation of linear control valves. The available combinations of case sizes, strokes, and springs precisely satisfy a wide range of application requirements.

### FEATURES

- *Rolling diaphragm provides excellent sensitivity and provides maximum constant effective area which translates into improved linearity.*
- *Modular construction provides maximum part interchangeability between direct and reverse-acting models and between selected case sizes.*
- *High spring rates improve control valve stability.*
- *Minimal guiding assures low hysteresis in reverse-acting models—zero hysteresis in direct-acting models.*
- *Stainless steel stems are standard for maximum performance in corrosive environments.*

## Specifications

**Diaphragm Cases:** Pressed steel.

**Stem:** 303 SS.

**Diaphragm:** Dacron reinforced nitrile.

**Spring Barrel:** Cast Iron.

**Temperature Limits:** -40°F to +180°F (-40°C to +82°C).

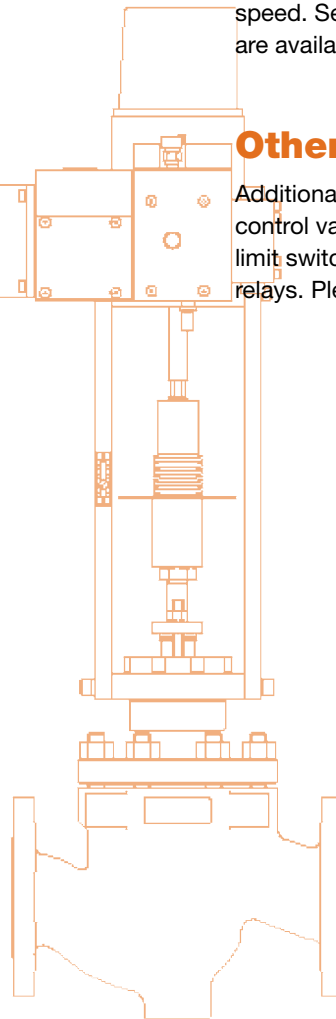
**Standard Spring Spans:** 12 psi and 24 psi (.8 bar and 1.7 bar), (other spans and spring preloads available on application).

## Positioners

Pneumatic, electro-pneumatic and digital positioners improve repeatability and accuracy while providing increased force to reduce actuator sizes. Pneumatic positioners accept a 3-15 psi input, while electro-pneumatic positioners typically accept a 4-20 mA signal. Most digital positioners provide extensive monitoring or diagnostics, as well as improved response speed. Several industry-recognized brands are offered. Others are available upon request.

## Other Accessories

Additional accessories available for mounting with linear control valves include, but are not limited to transducers, limit switches, lock-up valves, solenoid valves and amplifying relays. Please consult the factory for complete details.



KOSO HAMMEL DAHL  
4 Manley Street  
W. Bridgewater, MA 02379

(P) 508.584.1199  
(F) 508.584.2525  
[www.hammeldahl.com](http://www.hammeldahl.com)