

## FEATURES

- *Globe bodies for in-line service; angle bodies for difficult service. Each body style accepts all standard trim sets.*
- *Balanced plugs for use with smaller more economical actuators. Unbalanced plugs for simplicity of design, fewer parts, and ease of maintenance.*
- *Standard linear or equal percentage characterized ported cages; optional linear or equal percentage Flash Flo® cages for difficult applications.*
- *Maximum parts interchangeability and simplicity of design result in minimum parts inventories and lower maintenance costs.*
- *All cages for a given valve size have constant bore diameters, therefore all plugs are interchangeable regardless of design, requiring fewer part replacements. (1 1/2" - 8" sizes)*
- *C<sub>v</sub> reductions are achieved by reducing the area of the cage openings, not by changing its diameter or valve travel, thus eliminating the need for changing actuators.*

## Series V510/V520 Globe And Angle Valves 1/2"- 8" (DN15 - 200) ANSI Class 900-2500

The V510 (ANSI Class 900 and 1500) and V520 (ANSI Class 2500) Series control valves are heavy cage guided type globe and angle valves with "quick change" trim. Designed for high temperature and high pressure applications, these valves feature a close tolerance integral cage and seat ring for accurate, vibration free service. The pressure drop in this design occurs across the cage openings (ports) rather than the seating surface, thus minimizing seat wear and seat leakage. Applications include throttling and on/off control of non-gritty liquids, gases, and steam at moderate to high temperature and pressures.

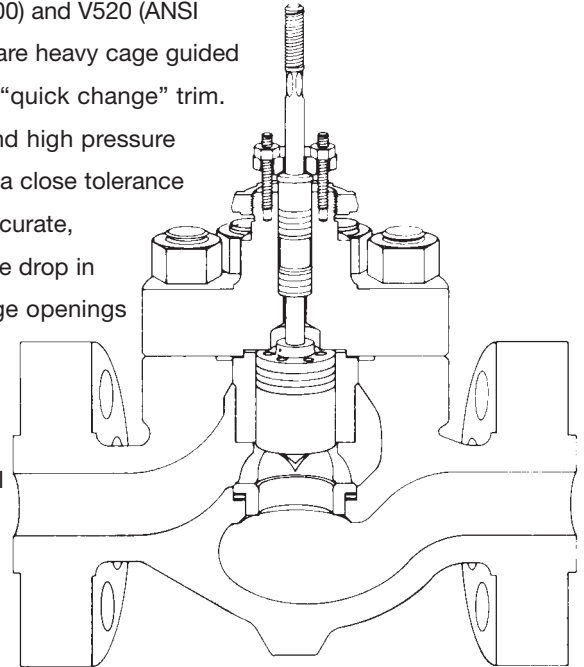

## Specifications

**Body Style:** Cage guided globe or angle

**Body Size:** 1/2" through 8" (15-200 mm)

**Body Rating:** ANSI Class 900, 1500 (1/2" through 8"); ANSI Class 2500 (1" through 3")

**Body Materials:** Carbon steel, stainless steel, chrome-moly steel, other castable alloys

**End Connections:** Socket weld, butt weld, raised face flange, ring type joint and others on application

**Bonnets:** Plain or extension

**Trim Style:** Balanced or unbalanced plug, standard ported or Flash Flo® cage with integral seat ring.

**Trim Characteristic:** Linear or equal percentage

**Flow Coefficient:** C<sub>v</sub> from 0.40 through 680 (refer to Tables 3, 4 and 5).

**Leakage Class:** ANSI Class II through V

**Actuators:** Standard bonnet mount will accept either spring-diaphragm or piston actuators. For actuator selection refer to KOSO Hammel Dahl actuator selection guide.

## Trim Designs

The V510 Series and the V520 Series are two separate product lines each designed to be a fully integrated, interchangeable system of parts. While all parts are common within each series, parts cannot be interchanged between series.

Standard trim sets for the 1/2" - 1" ANSI Class 900 and 1500 and 1" ANSI Class 2500 valve bodies include a seat ring, a cage that acts as the seat ring retainer and the guide for a contoured plug (Fig. 3). Trim sets for all other valve bodies are cages with integral seats and piston style plugs (Figures 1, 2, 4, 5, 6).

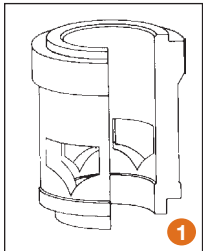

**Figure 1. Metal Seated Cage**

The standard cage construction is a cast cage with integral seat ring. The cage serves as a massive plug guide and the close tolerance fit eliminates plug vibrations at high differential pressures. The four cage openings are contoured to establish the flow characteristic. The cage shown has openings which will provide equal percentage characteristic. A linear characteristic is also available.

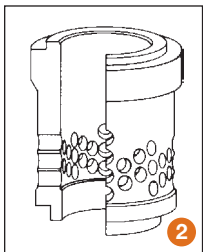
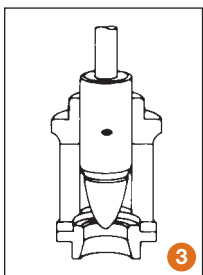

**Figure 2. Flash-Flo®**

This unique cage has a series of diametrically opposed drilled holes that break the flow stream into many smaller streams. For liquid applications, the Flash Flo® trim is used as “flow into the cage”.

Thus the high velocity streams impinge upon each other which dissipates the energy and keeps the cavitating liquid away from metal valve parts. For gas/steam applications, the Flash Flo® trim is used as “flow out of the cage”.

Thus the high velocity streams radiate out of the cage causing a redistribution of the acoustical energy with resultant noise attenuation. The Flash Flo® cage has an integral seat ring.



**Figure 3. Contoured Trim**  
(1/2"-1" ANSI Class 900, 1500 and 1" ANSI Class 2500 )

For the 1/2" - 1" globe valves the standard design is a cage with separable seat ring and cage guided contoured plug. In this design the flow area between the seat ring and the contoured plug is where throttling actually takes place.

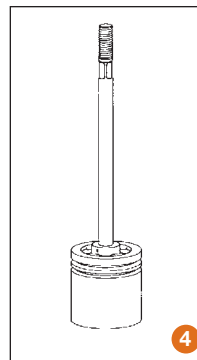

**Figure 4. Balanced Plug**

The standard balanced plug is piston style, which has a primary metal seat and secondary bidirectional piston rings set in ring grooves. The pressure above the plug is equalized with the pressure below the seat ring by large vent holes which pass completely through the plug. In the closed position, the plug rests on the seating surface machined in the cage and the piston rings seal the annulus between the upper plug and cage.

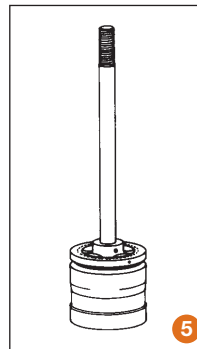

**Figure 5. Optional Balanced Plug**

This unique design includes a special uni-directional, spring-loaded, pressure-energized TFE cup seal. Upstream pressure enters the seal cavity compressing the seal outward, sealing the annulus between the plug and cage walls.

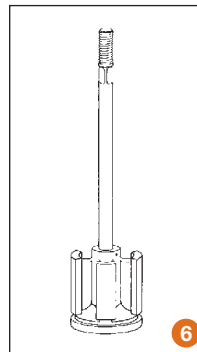

**Figure 6. Unbalanced Plug**

The unbalanced plug (no vent holes) is used in only flow from under the plug applications. The plug is grooved along its sides to equalize pressure in the valve body above the seat with the pressure above the plug.

The V510 Series and the V520 Series together fulfill the design concept of a streamline product offering which provides maximum versatility and flexibility, yet requires a minimum of inventory and maintenance time.

**Table 1. Flow Direction**

Media	Plug	Cage	Flow Direction
Clean Liquids	Balanced	Ported	Flow Over
		Flash Flo®	
	Unbalanced	Ported	Flow Under
		Flash Flo®	Consult Factory
Gas or Steam	Balanced	Ported	Flow Over
		Flash Flo®	Flow Under
	Unbalanced	Ported	
		Flash Flo®	

**NOTE:** Flow direction must be specified at time of order entry.

# Shutoff Performance

**Table 2. Valve Leakage Classes**

Plug Style	Seat Ring	Plug Seal	ANSI Class
Unbalanced	Metal	None	IV
	Metal	None	V†
Balanced	Metal	PTFE piston ring/O ring	IV
	Metal	Carbon Graphite	II
	Metal	Metal piston ring	III
	Metal	PTFE cup seal/spring	IV
			V†

Above leakage classes as defined in ANSI B16.104.

† Requires seat lapping.

Viton is a registered trademark of E.I. DuPont Co.



The unbalanced plug used in conjunction with any metal seat ring will provide Class IV shutoff or may be lapped to provide Class V shutoff.



The standard plug seal for temperatures below 400°F (204°C) is a PTFE piston seal energized by a Viton® “O” ring (refer to Figure 10 for pressure and temperature limitations). Supplied with any metal seated cage, this seal will provide Class IV shutoff.



A plug seal for temperatures and pressures beyond the capability of the PTFE piston ring is carbon graphite. This seal supplied with any metal seated cage will provide Class II shutoff.



The standard plug seal for temperatures and pressures beyond the capability of the standard PTFE piston ring is a metal piston ring, which provides Class III shutoff.



For those applications where Class V shutoff is required in a balanced valve, a special spring-loaded pressure-energized PTFE cup seal is available to be used in conjunction with a lapped seating surface. (Refer to Figure 10 for pressure and temperature limitations.)

# Flow Data

**Table 3. Flow Coefficient (C<sub>v</sub>) at Maximum Travel 1-1/2" - 8", ANSI Class 900-1500**

Plug Style	Cage Style	Flow Characteristic	Trim Size	Trim Code	Valve Size – inches					
					1-1/2	2	3	4	6	8
Balanced	Standard Ported	Equal Percentage	Full Size	A	28	50	95	160	330	560
			1 Red.	B	20	32	54	95	200	340
			2 Red.	C	13	21	38	60	114	185
		Linear	Full Size	A	28	54	110	180	365	590
			1 Red.	B	20	34	65	114	230	390
			2 Red.	C	13	21	42	68	140	245
	Flash Flo®	Equal Percentage	Full Size	A	29	46	105	135	296	—
			1 Red.	B	18	39	69	87	192	—
			2 Red.	C	—	29	42	54	117	—
		Linear	Full Size	A	28	40	83	127	350	680
			1 Red.	B	19	26	50	82	225	—
			2 Red.	C	11	17	37	50	135	285
Unbalanced	Standard Ported	Equal Percentage	Full Size	A	28	50	95	160	365	590
			1 Red.	B	20	32	54	95	192	336
			2 Red.	C	13	21	38	60	114	200
		Linear	Full Size	A	30	54	110	180	380	610
			1 Red.	B	20	34	65	114	220	385
			2 Red.	C	13	21	42	68	140	245

Table 4. Flow Coefficient ( $C_v$ ) at Maximum Travel 1/2" - 1", ANSI Class 900-1500

Plug Style	Flow Characteristic	Trim Size	Trim Code	Valve Size – inches		
				1/2	3/4	1
Unbalanced	Equal Percentage	Full Size	A	5.4	9.0	13.5
		1 Red.	B	3.5	5.4	9.0
		2 Red.	C	1.8	3.5	5.4
		3 Red.	D	1.4	1.8	3.5
		4 Red.	E	1.0	1.4	1.8
		5 Red.	F	.67	1.0	1.4
		6 Red.	G	–	.67	1.0
	7 Red.	H	–	–	.67	
	Linear	Full Size	A	4.5	6.9	13.0
		1 Red.	B	2.5	4.5	6.9
		2 Red.	C	1.7	2.5	4.5
		3 Red.	D	1.1	1.7	2.5
		4 Red.	E	.63	1.1	1.7
		5 Red.	F	.48	.63	1.1
6 Red.		G	–	.48	.63	
7 Red.	H	–	–	.48		

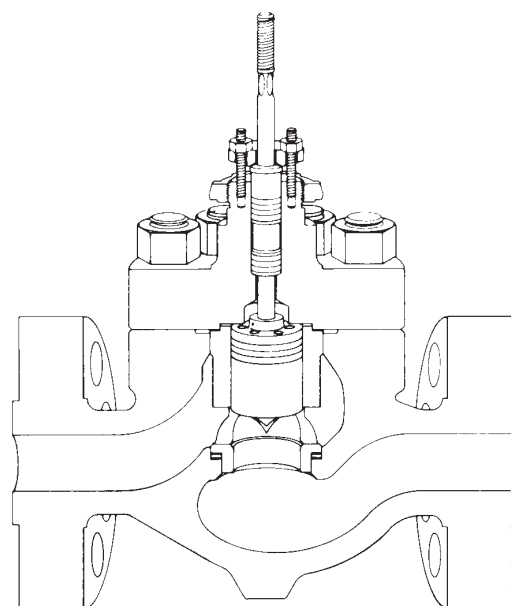
Table 5. Flow Coefficient ( $C_v$ ) at Maximum Travel 1" - 3", ANSI Class 2500

Plug Style	Cage Style	Flow Characteristic	Trim Size	Trim Code	Valve Size – inches			
					1	1 1/2	2	3
Unbalanced or Balanced(a)	Flash Flo® (a)	Equal Percentage	Full Size	A	9.0	24.0	38.0	78.0
			1 Red.	B	5.5	17.0	24.0	37.0
			2 Red.	C	3.0	11.0	15.0	21.0
			3 Red.	D	1.7	6.0	6.0	–
			4 Red.	E	1.0	3.5	3.5	–
			5 Red.	F	.63	2.5	2.5	–
			6 Red.	G	.4	1.7	1.7	–
			7 Red.	H	–	1.0	1.0	–
			8 Red.	J	–	.63	.63	–
		9 Red.	K	–	.4	.4	–	
		Linear	Full Size	A	9.0	24.0	38.0	82.0
			1 Red.	B	5.5	17.0	24.0	40.0
			2 Red.	C	3.0	11.0	15.0	24.0

a) Trim sets with  $C_v$  of 9 or lower are available unbalanced plug and ported style cage only.

## Material Selection

These charts should be used to select the pressure class and trim material combination. The set of curves sloping downward to the right are the pressure rating curves for each ANSI pressure class listed in ANSI B16.34. In each case the curve designates the maximum pressure and temperature for the class listed directly below the curve. The bold boundaries mark the recommended pressure and temperature limits for trim material combinations listed in Table 6. These recommendations are generalized and may be subject to adjustment based upon hydraulic considerations determined during the valve sizing process.

Figure 7. Trim Chart For Carbon Steel Body  
(ASTM A 216, WCB)

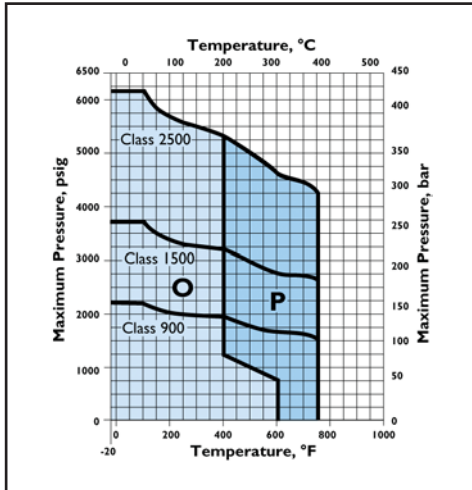

Figure 8. Trim Chart For Stainless Steel Body  
(ASTM A 351, CF8M)

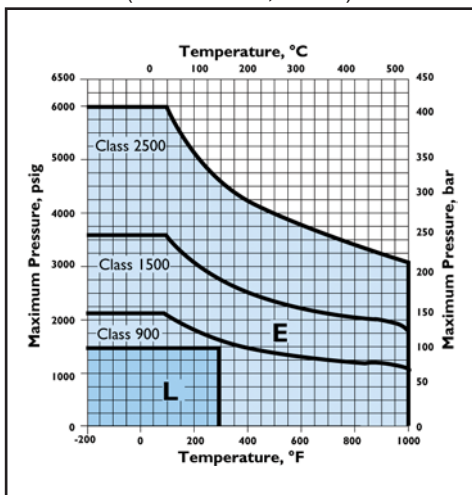

Table 6. Trim Materials

Trim Code	Plug	Cage	Stem
E	316 SS HFS+G	316 SS CP-HFS	316 SS
L	316 SS HFS	316 SS CP-HFS	316 SS
O	416 SS	17-4PH/CP	316 SS
P	316 SS HFS+G	Alloy 6*	316 SS

\* Available in Flash Flo® configuration only.

### NOTES TO TABLE AND TRIM CHARTS

- Above +600°F (316°F) extension bonnet is required.
- For service temperature above +1000°F (+538°C) contact your local representative.
- Unless otherwise specified, the hard-facing is Alloy 6.
- CP= Chrome plated.
- KOSO Hammel Dahl reserves the right to substitute materials when appropriate based upon service or availability.

Figure 9. Trim Chart For Chrome-Moly Body  
(ASTM A 217, C5)

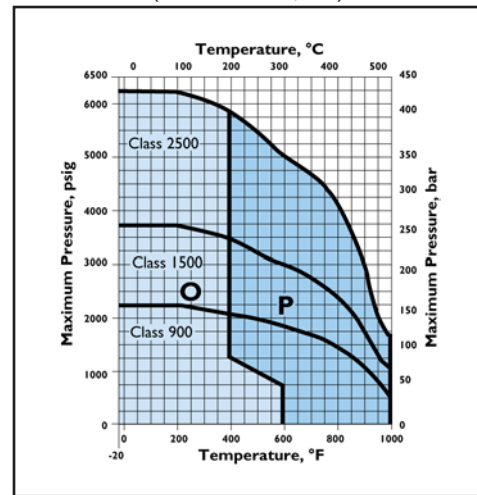

Figure 10. TFE Plug Seal Rating Chart

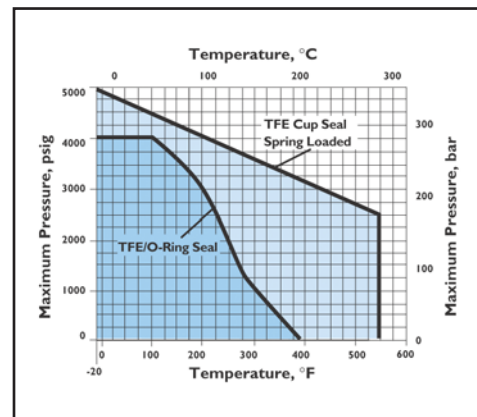
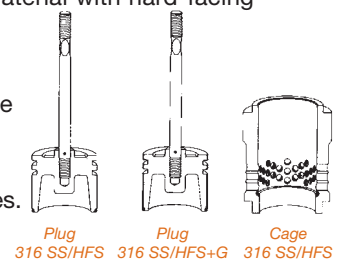

Figure 11. Hard Facing

Two styles of hard-facing are provided for difficult service applications.

HFS is 316 stainless steel base material with hard-facing on the seating surfaces of the plug and cage.

HFS & G is 316 stainless steel base material with hard-facing on the seating surfaces of the plug and cage and the plug guiding surfaces.



## Bonnet Types

### Plain Bonnet

A plain bonnet is used when the flow medium remains between -50°F and +600°F (-45°C to +316°C).

### Extension Bonnet

An extension bonnet is required for low temperature applications (-50°F or -129°C) and high temperature applications (+600°F to +1000°F or +316°C to +538°C).

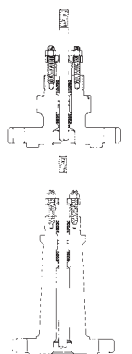

# Dimensional Data

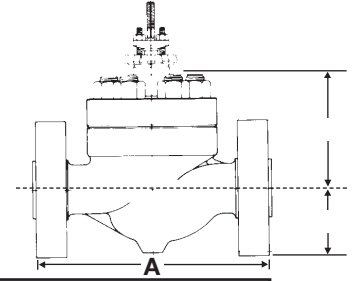

## V510, V512, V520, V522

Body Size Inches (mm)	Travel	A										C		D			
		Socket Weld		Raised Face Flanged			Ring-Type Joint Flanged			Butt Weld				Plain Bonnet		Extension Bonnet	
		Class 900-1500	Class 2500	Class 900	Class 1500	Class 2500	Class 900	Class 1500	Class 2500	Class 900-1500	Class 2500	Class 900-1500	Class 2500	Class 900-1500	Class 2500	Class 900-1500	Class 2500
1/2 (13)	1.00 (25)	11.00 (279)	—	—	—	—	—	—	—	—	—	2.62 (67)	—	5.88 (149)	—	10.00 (254)	—
3/4 (20)	1.00 (25)	11.00 (279)	—	11.50 (292)	11.50 (292)	—	—	—	—	—	—	2.62 (67)	—	5.88 (149)	—	10.00 (254)	—
1 (25)	1.00 (25)	11.00 (279)	12.50 (318)	11.50 (292)	11.50 (292)	12.50 (318)	11.50 (292)	11.50 (292)	12.50 (318)	—	—	2.62 (67)	3.25 (83)	5.88 (149)	8.38 (213)	10.00 (254)	12.50 (318)
1 1/2 (40)	1.13 (29)	13.00 (330)	15.00 (381)	13.12 (333)	13.12 (333)	15.00 (381)	13.12 (333)	13.12 (333)	15.12 (384)	—	15.00 (381)	3.38 (86)	3.56 (90)	6.60 (168)	8.38 (213)	11.44 (291)	13.06 (332)
2 (50)	1.13 (29)	14.75 (375)	15.75 (400)	14.75 (375)	14.75 (375)	16.25 (413)	14.88 (378)	14.88 (378)	16.38 (416)	—	15.75 (400)	3.75 (95)	4.06 (103)	7.34 (186)	8.75 (222)	11.56 (294)	14.56 (370)
3 (80)	1.50 (38)	—	—	17.38 (441)	18.12 (460)	26.00 (660)	17.50 (445)	18.25 (464)	26.25 (667)	18.12 (460)	26.00 (660)	4.88 (124)	7.38 (187)	10.12 (257)	16.50 (419)	12.62 (321)	24.00 (610)
4 (100)	1.50 (38)	—	—	20.12 (511)	20.88 (530)	—	20.25 (514)	21.00 (533)	—	20.88 (530)	—	5.56 (141)	—	11.12 (282)	—	13.88 (353)	—
6 (150)	2.25 (57)	—	—	28.12 (714)	30.25 (768)	—	28.25 (718)	30.50 (775)	—	30.25 (768)	—	7.00 (178)	—	18.63 (473)	—	26.13 (664)	—
8 (200)	3.50 (89)	—	—	36.00 (914)	38.25 (972)	—	36.12 (917)	38.62 (981)	—	38.25 (972)	—	10.00 (254)	—	17.88 (454)	—	22.12 (562)	—

## V511, V513, V521, V523

Body Size Inches (mm)	Travel	A										D			
		Socket Weld		Raised Face Flanged			Ring-Type Joint Flanged			Butt Weld		Plain Bonnet		Extension Bonnet	
		Class 900-1500	Class 2500	Class 900	Class 1500	Class 2500	Class 900	Class 1500	Class 2500	Class 900-1500	Class 2500	Class 900-1500	Class 2500	Class 900-1500	Class 2500
1/2 (13)	1 (25)	5.50 (140)	—	—	—	—	—	—	—	—	—	5.88 (149)	—	10.00 (254)	—
3/4 (20)	1 (25)	5.50 (140)	—	5.75 (146)	5.75 (146)	—	—	—	—	—	—	5.88 (149)	—	10.00 (254)	—
1 (25)	1 (25)	5.50 (140)	6.25 (159)	5.75 (146)	5.75 (146)	6.25 (159)	5.75 (146)	5.75 (146)	6.25 (159)	—	7.50 (191)	5.88 (149)	8.38 (213)	10.00 (254)	12.50 (318)
1 1/2 (40)	1.13 (29)	6.50 (165)	7.50 (191)	6.56 (167)	6.56 (167)	7.50 (191)	6.56 (167)	6.56 (167)	7.56 (192)	—	7.88 (200)	6.62 (168)	8.38 (213)	11.44 (291)	13.06 (332)
2 (50)	1.13 (29)	7.38 (187)	7.88 (200)	7.38 (187)	7.38 (187)	8.12 (206)	7.44 (189)	7.44 (189)	8.19 (208)	—	13.00 (330)	7.38 (187)	8.75 (222)	11.56 (294)	14.56 (370)
3 (80)	1.5 (38)	—	—	8.69 (221)	9.06 (230)	—	8.75 (222)	9.12 (232)	—	9.06 (230)	—	10.12 (257)	—	12.62 (321)	—
4 (100)	1.5 (38)	—	—	10.06 (256)	10.44 (265)	—	10.12 (257)	10.50 (267)	—	10.44 (265)	—	11.12 (282)	—	13.88 (353)	—
6 (150)	2.25 (57)	—	—	14.06 (357)	15.12 (384)	—	14.12 (359)	15.25 (387)	—	15.12 (384)	—	14.00 (356)	—	18.69 (475)	—

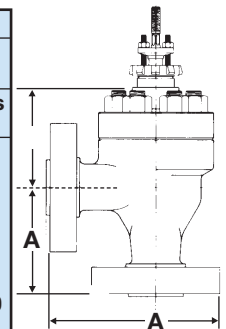

Globe style face-to-face dimensions are in accordance with ANSI B16.10 and ISA S75.16 for raised face flanged valves.

# How To Order

To completely specify a control valve, make a selection from each category in the Valve Model Coding System below. The assembled codes create a complete valve model number. The Valve Model Coding System displays the standard product offering for this product line. An extensive number of options and variations exist, which are not listed. For options not shown or to enter an order, contact your local sales representative.

V510	N	N	K	5	3	F	B	P	9	B
1	2	3	4	5	6	7	8	9	10	11

1	Model	
	ANSI Class 900, 1500	ANSI Class 2500
V510	Balanced, Globe Body	V520 Balanced, Globe Body (1 1/2" - 3" size)
V511	Balanced, Angle Body	V521 Balanced, Angle Body (1 1/2" - 2" size)
V512	Unbalanced, Globe Body	V522 Unbalanced, Globe Body (1" - 3" size)
V513	Unbalanced, Angle Body	V523 Unbalanced, Angle Body (1" - 2" size)

2	Body Size
D	1/2" (13 mm)
E	3/4" (20 mm)
F	1" (25 mm)
H	1 1/2" (40 mm)
J	2" (50 mm)
L	3" (80 mm)
N	4" (100 mm)
Q	6" (150 mm)
S	8" (200 mm)

3	Rating
M	ANSI Class 900
N	ANSI Class 1500
R	ANSI Class 2500*

\*1" through 3" valves only.

4	Body Material
C	Carbon Steel (ASTM A216, WCB)
E	Stainless Steel (ASTM A351, CF8M)
K	Chrome-Moly Steel (ASTM A217, C5)

5	End Connections
3	Raised Face Flange
5	Ring Type Joint Flange
6	Socket Weld
9	Butt Weld Sch. 80*
A	Butt Weld Sch. 160

\* ANSI Class 900 and 1500 only.

6	Bonnet Type
2	Plain
3	Extension

7	Trim Characteristics
C	Linear, Ported
E	Equal Percentage, Ported
F	Flash-Flo® Equal Percentage
H	Flash-Flo®, Linear

8	Trim Size
A	Full Size
B	1 Reduction
C	2 Reduction

NOTE: Refer to Cv tables on pages 3 and 4 for additional options.

9	Trim Materials		
Trim Code	Plug	Cage	Stem
E	316 SS/HFS+G	316 SS/CP-HFS	316 SS
L	316 SS/HFS	316 SS/CP-HFS	316 SS
O	416 SS	17-4PH/CP	316 SS
P	316 SS/HFS+G	Alloy 6*	316 SS

\* Available in Flash-Flo® configuration only.

10	Packing
	-200°F to +450°F (-129°C to +232°F)
G	PTFE V-Ring with Packing Spacer
U	PTFE Impregnated PTFE Braided Ring
	+450°F to +1000°F/+232°C to +538°C
9	Laminated Graphite Ring

11	Variations
—	None
B	Plug Seal Ring - Metal
1	Body Drain (1/2" NPT)
J	Plug Seal Ring - TFE/O-Ring
K	Plug Seal Ring - Carbon Graphite
N	Plug Seal Ring - TFE Cup Seal, Spring Loaded
8	Stainless Steel Body Studs and Nuts
9	Stainless Steel Lubricator and Isolating Valve

NOTE: If more than one variation is required, use code "Z" and describe each variation.

NOTE: A plug seal must be specified in the variation code for all balanced style valves.  
NOTE: Flow direction must be specified at time of order entry.

## D/R Series Linear Spring Diaphragm Pneumatic Actuators

KOSO Hammel Dahl linear spring diaphragm pneumatic actuators are rugged units designed for reliable operation of linear control valves. The available combinations of case sizes, strokes, and springs precisely satisfy a wide range of application requirements.

### FEATURES

- *Rolling diaphragm provides excellent sensitivity and provides maximum constant effective area which translates into improved linearity.*
- *Modular construction provides maximum part interchangeability between direct and reverse-acting models and between selected case sizes—field reversibility is easily accomplished.*
- *High spring rates improve control valve stability.*
- *Minimal guiding assures low hysteresis in reverse-acting models—zero hysteresis in direct-acting models.*
- *Stainless steel stems are standard for maximum performance in corrosive environments.*

## Specifications

**Diaphragm Cases:** Pressed steel

**Stem:** 303 SS

**Diaphragm:** Dacron reinforced nitrile

**Spring Barrel:** Cast Iron

**Max. Case Pressure:** 65 psi (4.5 bar)

**Temperature Limits:** -40°F to +180°F (-40°C to +82°C)

**Standard Spring Spans:** 12 psi and 24 psi (.8 bar and 1.7 bar)  
(other spans and spring preloads available on application)

## REXA Electraulic™ Actuators

The REXA actuator is a programmable, self-contained, electro-hydraulic actuator designed specifically for modulating control. REXA actuators combine the speed, power and repeatability of non-compressible hydraulics with the flexibility of a dedicated microprocessor. Available in a wide range of sizes and product options, there is a REXA actuator to meet even the most demanding control applications.

## Positioners

The NP700A and NE700A are proportional positioners for globe valve throttling applications. The NP is a fully pneumatic unit while the NE is an electro-pneumatic unit that provides pneumatic out-put proportional to a standard millampere DC Input. The ND800 digital positioner provides extensive monitoring for diagnostics as well as improves response speed. Used with D/R Series diaphragm actuators, these units improve repeatability and accuracy while providing increased force to reduce actuator sizes. KOSO and other instrument manufacturers positioners are also available upon request.

## Other Accessories

Additional accessories available for mounting with linear control valves include, but are not limited to transducers, limit switches, lock-up valves, solenoid valves and amplifying relays. Please consult the factory for complete details.

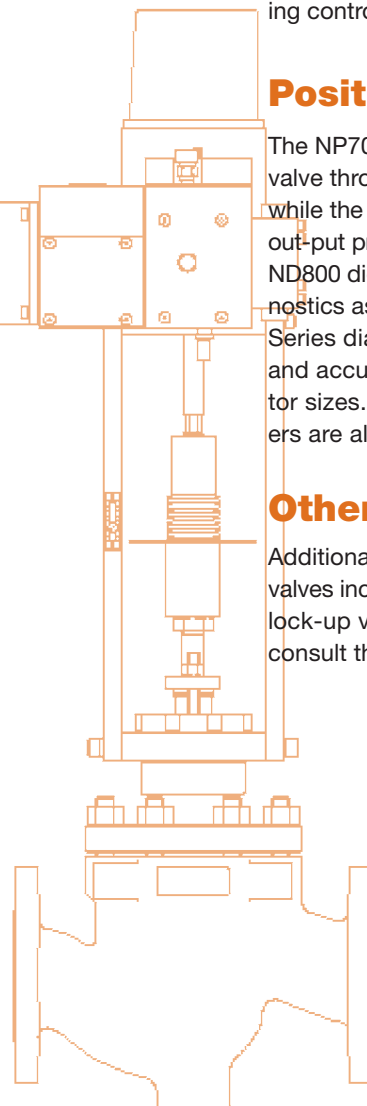

### KOSO AMERICA, INC.

4 Manley Street  
W. Bridgewater, MA 02379

Telephone: 508.584.1199

Fax: 508.584.2525

[www.hammeldahl.com](http://www.hammeldahl.com)